

PSA-STARPOINT PSA-VRS M12

Artikel-Nr: 7997100



- **Lifting points pivots 360°**
- **They are corresponding to a "anchor point" according to European edict 2016/425** and the DIN 795:2012-10 resp. DIN CEN / TS 16415:2013-4 and they are marked with the number of load bearing persons (=1 or 2 persons).
- **These products are tested by a notified institution of DGUV** (Deutsche Gesetzliche Unfallversicherung) with the evidence of the in OSHA 1926.502: 2001/01 paragraph (d)(15) and DIN EN 50308:2005 chapter 4.5 for lifting points required Forces.
- **Non removable special bolt** (this reduces the risk of improper standard bolts).
- Available as: - Standard Metric Thread (DIN EN 13) - Coarse Pitch Thread UNC (ANSI B1.1)
- Quick and easy installation with just one bolt connection.
- Hand tightening with appropriate wrench is sufficient for a singular lift.

Other important RUD specific information and specialities to our RUD lifting points can be found in the specific user instruction.

PSA-STARPOINT PSA-VRS M12

Artikel-Nr: 7997100

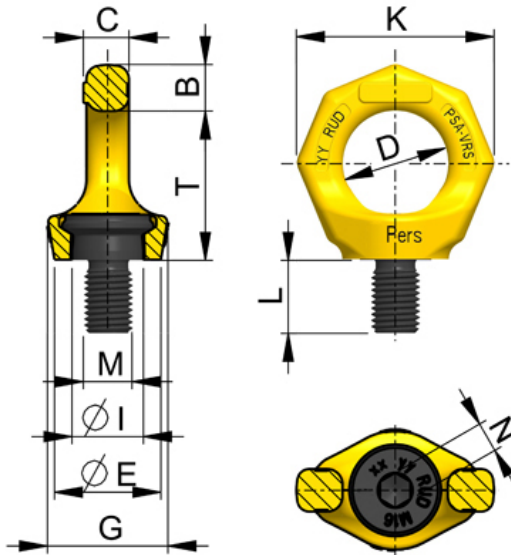

	weight	0.20 kg	0.44 lbs
T	42 mm	1-21/32"	
B	13 mm	1/2"	
C	10 mm	3/8"	
D	30 mm	1-3/16"	
E	30 mm	1-3/16"	
G	34 mm	1-11/32"	
I	19,8 mm	25/32"	
K	56 mm	2-3/16"	
L	18 mm	23/32"	
M	M12 mm	M12	
N	8 mm	5/16"	